



ÍNDICE

Factores de conversión	7
Alambres pulidos y galvanizados	9
Alambre Pulido en barra de 6 m.	9
Malla electrosoldada por rollo	9
Malla electrosoldada ferretera por rollo	9
Alambrón	9
Tubería negra y galvanizada	
C-40 y N-X tramos de 6.40 mts.	11
Tubo mecánico Ced. 30	12
Tubo industrial	13
Tubo grandes dimensiones	15
Lámina antiderrapante R.F. Zarpa	17
Lámina antiderrapante R.C. Zarpa	17
Lámina galvanizada R-90	17
Lámina galvanizada tabla de tolerancias	17
Lámina galvanizada lisa y acanalada	
030 - R-72 - R-101	18
Lámina negra tabla de tolerancias	19
Lámina negra L.C. y L.F. (C.C, B y A, T.P. y T.E.P.)	20
Placa de acero A-36 medidas standard	
tabla de pesos aproximados en kg.	23
Placa y lámina antiderrapante	
pesos y medidas	25
Losacero y Galvadek	25
H.S.S. - O.R.	27
Perfil P.E.R. características	31
Perfil Estructural Rectangular	
(P.E.R.) (P.T.R.) C.C. y A.R.	33

ÍNDICE

Perfil tubular pintado	34
Polines estructurales	36
Polines estructurales tabla de resistencias	36
Tableros Cal.20	37
Tablero galvanizado	37
Vagueta aluminio kg. por pieza	37
Canales - C.P.S.	37
Vigueta I.P.R.	39
Vigueta I.P.S.	41
Caramelo	43
Varilla corrugada alta resistencia	43
Cuadrados	43
Redondos	43
Tira de cortina	43
Cuadrado ligero	43
Clavo	43
Ángulos	45
Ángulos ligeros	45
Ángulos desiguales	45
Soleras	47
Soleras cortadas de lámina	48
Solera pasamano	48
Te	48
Zeta	48
Perfiles tubulares muestrario	50
Duela para ensamblar	55
Tableros para puerta	55

FACTORES DE CONVERSIÓN

Multiplicar	por	para obtener
Milésimas de pulg.	0.001	pulg.
Milésimas de pulg.	0.02540	mm.
Pulgadas	1.000	milésimas de pulg.
Pulgadas	25.40	mm.
Pulgadas	2.540	cm.
Pulgadas	0.02540	metros
Pies	30.48	cm.
Pies	0.3048	metros
Yardas	0.9144	metros
Millas	1.6093	km.
Milímetros	39.37	mm de pulg.
Milímetros	0.03937	pulg.
Centímetros	0.3937	pulg.
Centímetros	0.03281	pies
Metros	39.37	pulg.
Metros	3.281	pies
Metros	1.0936	yardas
Kilómetros	0.6214	millas
Milésimas de pulg. ²	0.000001	pulg. ²
Pulgadas ²	1,000.000	milésimos de pulg. ²
Pulgadas ²	645.2	mm. ²
Pulgadas ²	6.452	cm. ²
Pies ²	0.09290	m. ²
Milímetros ²	0.0015500	pulg. ²
Centímetros ²	0.15500	pulg. ²
Metros ²	10.764	pulg. ²
Libras	0.4536	kg.
Libras por pulg. ²	0.07031	kg. por cm. ²
Kilogramos	2.2046	libras
Kilogramos por cm. ²	14.223	lbs. por pulg. ²

ALAMBRES (PULIDOS Y GALVANIZADOS)

ALAMBRE PULIDO EN BARRA DE 6.00m

Número	Diámetros		Kilos por km.	No. de m. en 1 kg.	Medidas		Kilos por metro
	mm.	pulg.			pulg.	m. m.	
0000	10.00	0.3938	610.6	-	4.8	3/16	0.146
000	9.21	0.3626	517.0	-	6.3	1/4	0.249
00	8.41	0.3310	433.1	-	7.9	5/16	0.388
0	7.79	0.3065	372.6	-	9.5	3/8	0.599
1	7.19	0.2830	316.6	3.16	12.7	1/2	0.994
2	6.67	0.2625	272.6	3.67			
3	6.19	0.2437	234.7	4.26			
4	5.72	0.2253	200.6	4.98			
5	5.26	0.2070	169.4	5.90			
6	4.88	0.1920	145.7	6.86			
7	4.50	0.1770	123.9	8.08			
8	4.12	0.1620	103.8	9.64			
9	3.77	0.1483	86.9	11.50			
10	3.43	0.1350	72.1	13.88			
10 1/2	3.10	0.1220	74.0	13.52			
11	3.06	0.1205	57.4	17.42			
12	2.68	0.1055	44.0	22.73			
12 1/2	2.35	0.0925	48.0	28.83			
13	2.32	0.0915	33.2	30.22			
14	2.03	0.0800	25.3	39.53			
15	1.83	0.0720	20.5	48.80			
16	1.59	0.0625	15.6	64.73			
17	1.37	0.0540	11.5	86.72			
18	1.21	0.0475	8.7	112.04			
19	1.04	0.0409	8.2	122.0			
20	0.88	0.0346	2.9	344.8			
22	0.73	0.0286	3.1	309.31			

Alambres Recocidos			
Calibre	16	17	18

**PESO MALLA
ELECTROSOLDADA
POR ROLLO
2.50 X 40m**

66-44	257 kg.
66-66	187 kg.
66-88	130 kg.
66-1010	93 kg.

**MALLA
ELECTROSOLDADA
FERRETERA
POR ROLLO
1.25 X 20m**

66-1010	24 kg.
66-66	48 kg.

ALAMBRÓN

1/4	6.3	(2)	0.248
-----	-----	-----	-------

DIMENSIONES DE TUBERÍA NEGRA Y GALVANIZADA C-40 Y N-X/TRAMOS DE 6.40m

Tamaño Nominal		Espesor de pared		Diámetros		Peso por tubo de C-40 y N-X			
pulg.	mm.	pulg.	mm.	Externo pulg.	mm.	Interno pulg.	mm.	Negro	Galvanizado
1/8	3.17	0.068	1.727	0.405	10.287	0.269	6.833	2.257	-
1/4	6.35	0.088	2.235	0.540	13.716	0.364	9.246	4.411	4.500
3/8	9.52	0.091	2.311	0.675	17.145	0.493	12.522	5.962	6.047
1/2	12.70	0.109	2.769	0.840	21.336	0.622	15.799	8.658	8.752
3/4	19.05	0.113	2.870	1.050	26.670	0.824	20.930	11.285	11.611
1	25.40	0.133	3.378	1.315	33.401	1.049	26.645	16.144	16.909
1 1/4	31.75	0.140	3.556	1.660	42.164	1.380	35.052	22.306	22.892
1 1/2	38.10	0.141	3.683	1.900	48.260	1.610	40.894	26.142	27.148
2	50.80	0.154	3.912	2.375	60.325	2.067	52.502	36.288	36.855
2 1/2	63.50	0.203	5.156	2.875	73.025	2.469	62.713	58.187	58.667
3	76.20	0.216	5.486	3.500	88.900	3.068	77.927	75.003	75.853
4	101.60	0.237	6.020	4.500	114.300	4.026	102.260	105.642	105.833
Nx 1/2	13	0.090	2.29	0.840	21.3			6.72	
Nx 3/4	19	0.095	2.41	1.050	26.7			9.216	
Nx 2 1/2	63.50	0.160	4.064	2.875	73.025	2.555	64.897	46.167	47.177
Nx 3	76.20	0.170	4.318	3.500	88.900	3.160	80.264	57.200	60.538
Nx 4	101.60	0.188	4.775	4.500	114.300	4.124	104.750	86.182	89.700

(Ced.30) TUBO MECÁNICO

Tramo comercial 6.00 m

Diámetro		Espesor de pared	Peso Teórico	
Nominal Exterior			kg/m	kg/6m
13 mm.	21.33 mm.	1.7094 mm.	0.900	5.400
(1/2")	(0.840")	(.067")		
19 mm.	26.67 mm.	1.7094 mm.	1.125	6.750
(3/4")	(1.050")	(.067")		
25 mm.	33.40 mm.	1.8974 mm.	1.500	9.000
(1")	(1.315")	(.075")		
32 mm.	42.16 mm.	2.2784 mm.	2.350	14.100
(1 1/4")	(1.660")	(.090")		
38 mm.	48.26 mm.	2.2784 mm.	2.700	16.200
(1 1/2")	(1.900")	(.090")		
51 mm.	60.32 mm.	2.6568 mm.	3.950	23.700
(2")	(2.375")	(.105")		
64 mm.	73.03 mm.	2.6568 mm.	4.800	28.800
(2 1/2")	(2.875")	(.105")		
76 mm.	88.90 mm.	3.0378 mm.	6.700	40.200
(3")	(3.500")	(.120")		
102 mm.	114.30 mm.	3.0378 mm.	8.600	51.600
(4")	(4.500")	(.120")		

TUBO INDUSTRIAL

Diám. mm.	Ext. pulg.	Cal.	Peso Teórico		Diám. mm.	Ext. pulg.	Cal.	Peso Teórico	
			Kg/m	Kg/6m.				Kg/m	Kg/6m.
9	3/8	16	0.330	2.000	38.1	1 1/2	14	1.827	10.962
		18	0.250	1.500			16	1.461	9.000
		20	0.200	1.200			18	1.169	7.200
12.7	1/2	16	0.500	3.000	41.3	1 5/8	20	0.877	5.400
		18	0.389	3.000			14	1.980	11.880
		20	0.292	2.000			16	1.548	9.504
15.8	5/8	14	0.762	4.572	44.4	1 3/4	18	1.267	7.602
		16	0.610	3.660			20	0.950	5.700
		18	0.488	2.928			14	2.129	12.774
19.05	3/4	20	0.366	2.300	47.6	1 7/8	16	1.703	10.218
		14	0.913	5.478			18	1.362	8.172
		16	0.730	4.380			20	1.022	6.132
20.6	13/16	18	0.585	3.510	50.8	2 1/8	14	2.282	13.692
		20	0.438	2.628			16	1.826	10.956
		14	0.989	5.934			18	1.461	8.766
22.2	7/8	16	0.791	4.746	54.0	2 1/4	20	1.095	6.570
		18	0.633	3.798			14	2.346	14.616
		20	0.475	2.850			16	1.949	11.694
23.8	15/16	18	0.633	3.798	57.1	2 3/8	18	1.559	9.600
		20	0.475	2.850			20	1.169	7.200
		14	1.064	6.384			16	2.250	13.500
25.4	1"	16	0.852	5.112	60.4	2 1/2	18	1.660	10.000
		18	0.681	4.200			14	2.738	16.428
		20	0.500	3.000			16	2.190	13.140
28.5	1 1/8	14	1.140	6.840	63.5	2 7/8	18	1.752	10.512
		16	0.913	5.478			20	1.314	7.884
		18	0.730	4.380			14	2.864	17.184
31.7	1 1/4	20	0.548	3.288	73.0	3"	16	2.305	13.830
		14	1.218	7.308			18	1.849	11.094
		16	0.974	6.000			20	1.383	8.298
33.4	1 3/8	18	0.779	5.300	76.2	3 1/2	14	3.045	18.270
		20	0.585	3.700			16	2.436	14.616
		14	1.371	8.266			18	1.949	11.694
38.1	1 7/8	16	1.097	6.582	88.9	4"	20	1.461	8.766
		18	0.878	5.268			14	3.473	20.838
		20	0.658	3.948			16	2.798	16.788
41.3	2"	14	1.520	9.120	101.4	4 1/2	18	2.239	13.434
		16	1.216	7.296			14	3.650	21.900
		18	0.973	6.000			16	2.920	17.520
44.4	2 1/4	20	0.730	4.380	114.3	5"	18	2.336	14.016
		14	1.673	10.038			14	4.200	25.200
		16	1.338	8.028			16	3.600	21.500
47.6	2 3/8	18	1.071	6.426	127.0	5 1/2	18	3.030	18.200
		20	0.803	4.818			14	4.680	28.100
		14	1.673	10.038			16	3.750	22.500
50.8	2 7/8	16	1.338	8.028	141.3	6"	18	3.200	19.200
		18	1.071	6.426			14	4.680	28.100
		20	0.803	4.818			16	3.750	22.500

LÁMINA ANTIDERRAPANTE
R.F. (Zarpa)

Calibre	Pies 3 x 10	Pies 4 x 10
14	42.525	57.00
16	34.02	45.359
18	27.216	36.287
20	20.412	27.215

LÁMINA ANTIDERRAPANTE
R.C. (Zarpa)

Calibre	Pies 3 x 10	Pies 4 x 10
14	42.525	56.699

LÁMINA GALVANIZADA R-90

Calibre	Largo Metros	Largo Pies	Peso por hoja
26	3.66		18.040
26	4.88	16	24.060
26	5.50	18	27.120
26	6.10	20	30.070
24	7.30	24	41.390

TABLA DE TOLERANCIAS
LÁMINA GALVANIZADA

Calibre No.	Milésimas de pulgada	
	Medida	Tolerancia
10	0.1382	0.1457 a 0.1308
12	0.1084	0.1158 a 0.1009
14	0.0785	0.0859 a 0.0748
16	0.0635	0.0672 a 0.0606
18	0.0516	0.0545 a 0.0486
20	0.0396	0.0425 a 0.0382
22	0.0336	0.0351 a 0.0322
24	0.0276	0.0291 a 0.0262
26	0.0217	0.0231 a 0.0210
28	0.0187	0.0194 a 0.0180
30	0.0157	0.0164 a 0.0150

LÁMINA GALVANIZADA LISA Y ACANALADA - (030-R-72-R-101)
 TABLA DE PESOS POR HOJA EN KILOGRAMOS Y POR METRO LINEAL

Calibre	Esesor en mm.	1.83 m 3' x 6"	244 m 3' x 8"	3.05 3' x 10"	3.66 3' x 12"	2.44 4' x 8"	3.05 4' x 10"	3.66 4' x 12"	6.10 4' x 20"	91.5 cm. 3' ancho	122 cm. 4' ancho
10	3.470		62.08	77.61		82.78	103.47			25.46	33.95
12	2.710		48.48	60.60		64.64	80.80			19.88	26.51
14	1.950		34.87	43.59		46.49	58.11			14.30	19.07
16	1.570		28.07	35.08		37.42	46.78			11.51	15.35
18	1.270		22.62	28.28		30.16	37.70			9.28	12.37
20	0.970	12.88	17.18	21.47		22.91	28.63			7.05	9.39
22	0.813	10.84	14.46	18.07	21.68	19.28	24.10			5.93	7.91
24	0.584	7.78	10.37	12.97	15.56	13.83	17.29	20.75	34.58	4.25	5.67
26	0.508	6.76	9.01	11.27	13.52	12.02	15.02	18.04	30.07	3.70	4.93
28	0.432	5.74	7.65	9.57	11.48	10.21	12.76			3.14	4.19
30	0.358	4.72	6.29	7.86	9.44					2.58	
32	0.240	3.36	4.49	5.61	6.73						

TABLA DE TOLERANCIAS LÁMINA NEGRA

Calibre No.	Milésimas de pulgada			
	Medida		Tolerancia	
3	0.2391	0.2465	a	0.2317
4	0.2242	0.2316	a	0.2168
5	0.2092	0.2167	a	0.2018
6	0.1943	0.2017	a	0.1869
7	0.1793	0.1868	a	0.1719
8	0.1644	0.1718	a	0.1570
9	0.1495	0.1569	a	0.1420
10	0.1345	0.1419	a	0.1271
11	0.1196	0.1270	a	0.1131
12	0.1046	0.1120	a	0.0972
13	0.0897	0.0971	a	0.0822
14	0.0747	0.0821	a	0.0710
15	0.0673	0.0709	a	0.0636
16	0.0598	0.0635	a	0.0568
17	0.0538	0.0567	a	0.0509
18	0.0478	0.0508	a	0.0449
19	0.0418	0.0488	a	0.0389
20	0.0359	0.0388	a	0.0344
21	0.0329	0.0343	a	0.0314
22	0.0299	0.0313	a	0.0284
23	0.0269	0.0283	a	0.0255
24	0.0239	0.0254	a	0.0235
25	0.0209	0.0224	a	0.0195
26	0.0179	0.0194	a	0.0172
27	0.0164	0.0171	a	0.0157
28	0.0149	0.0156	a	0.0142
29	0.0135	0.0141	a	0.0128
30	0.0120	0.0127	a	0.0113
31	0.0105	0.0112	a	0.0101
32	0.0097	0.0100	a	0.0094

LÁMINA NEGRA L.C. Y L.F. (C.C,B Y A,T.P. Y T.E.P.)

Calibre	Espesor en mm.	Espesor en pulg.	Peso kg./pie ²	Peso kg/m ²	3 x 6	Hojas aprox. X tonelada	3 x 8	Hojas aprox. X tonelada	3 x 10	Hojas aprox. X tonelada	4 x 8	Hojas aprox. X tonelada	4 x 10	Hojas aprox. X tonelada
1/4	6.35	0.2500	4.7418	51.062	85.367	12	113.822	9	142.280	7	151.737	7	189.672	5
3	6.07	0.2391	4.5359	48.838	81.646	12	108.861	9	136.077	7	145.149	7	181.436	6
4	5.69	0.2242	4.2524	45.786	76.543	13	102.057	10	127.572	8	136.077	7	170.096	6
5	5.31	0.2092	3.9689	42.733	71.440	14	95.254	11	119.067	8	127.004	8	158.756	6
6	4.94	0.1943	3.6854	39.681	66.337	15	88.450	11	110.567	9	117.933	9	147.416	7
3/16	4.76	0.1875	3.5564	38.296	64.025	16	85.366	12	106.710	9	113.048	9	142.256	7
7	4.55	0.1793	3.4019	36.628	61.234	16	81.646	12	102.057	10	108.861	9	136.076	7
8	4.18	0.1644	3.1184	33.576	56.131	18	74.842	13	93.552	11	99.788	10	124.736	8
9	3.80	0.1495	2.8349	30.523	51.028	20	63.038	15	85.047	12	90.717	11	113.396	9
10	3.42	0.1345	2.5514	27.471	45.925	22	61.234	16	76.542	13	81.646	12	102.058	10
1/8	3.17	0.1250	2.3708	25.531	42.683	23	59.911	18	71.140	14	75.866	13	94.832	11
11	3.04	0.1196	2.2680	24.420	40.824	25	54.432	19	68.040	15	72.574	14	90.718	11
12	2.66	0.1046	1.9845	21.367	35.721	28	47.628	21	59.535	17	63.503	16	79.373	13
13	2.28	0.0897	1.7010	18.315	30.618	33	40.824	25	51.030	20	54.431	18	68.039	15
14	1.90	0.0747	1.4175	15.262	25.515	39	34.020	29	42.525	24	45.359	22	56.699	18
15	1.71	0.0673	1.2757	13.736	22.963	44	30.617	33	38.271	26	40.823	25	51.029	20
1/16	1.58	0.0625	1.1854	12.765	21.341	47	28.455	35	35.570	28	37.933	26	47.416	21

LÁMINA NEGRA L.C. Y L.F. (C.C,B Y A,T.P. Y T.E.P.)

Calibre	Espesor en mm.	Espesor en pulg.	Peso kg./pie ²	Peso kg/m ²	3 x 6	Hojas aprox. X tonelada	3 x 8	Hojas aprox. X tonelada	3 x 10	Hojas aprox. X tonelada	4 x 8	Hojas aprox. X tonelada	4 x 10	Hojas aprox. X tonelada
16	1.52	0.0598	1.1340	12.210	20.412	49	27.216	37	34.020	29	36.287	28	45.359	22
17	1.37	0.0538	1.0206	10.989	18.371	55	24.494	41	30.618	33	32.659	31	40.823	25
18	1.21	0.0478	0.9072	9.768	16.330	61	21.773	46	27.216	37	29.030	34	36.287	28
19	1.06	0.0418	0.7938	8.547	14.288	70	19.051	53	23.814	42	25.401	39	31.751	32
20	0.91	0.0359	0.6804	7.326	12.247	82	16.330	61	20.412	49	21.772	46	27.215	37
21	0.84	0.0329	0.6237	6.715	11.227	89	14.969	67	18.711	54	19.958	50	24.947	40
1/32	0.79	0.0312	0.5917	6.372	10.653	94	14.205	70	17.756	56	18.934	53	23.668	42
22	0.76	0.0299	0.5670	6.105	10.206	98	13.608	74	17.010	59	18.144	55	22.680	44
23	0.68	0.0269	0.5103	5.494	9.185	110	12.247	82	15.309	65	16.329	61	20.412	49
24	0.61	0.0239	0.4536	4.884	8.165	123	10.886	93	13.608	74	14.515	69	18.144	55
25	0.53	0.0209	0.3969	4.273	7.144	140	9.526	105	11.907	84	12.701	79	15.876	63
26	0.45	0.0179	0.3402	3.663	6.124	164	8.165	123	10.206	98	10.886	92	13.608	74
27	0.42	0.0164	0.3118	3.357	5.612	179	7.483	134	9.354	107	9.979	100	12.474	80
28	0.38	0.0149	0.2835	3.052	5.103	196	6.804	147	8.505	118	9.072	110	11.340	88
29	0.34	0.0135	0.2551	2.747	4.592	218	6.122	164	7.653	131	8.165	123	10.206	98
30	0.30	0.0120	0.2268	2.442	4.032	248	5.443	184	6.804	147	7.257	139	9.072	110
31	0.27	0.0105	0.1984	2.136	3.571	280	4.700	213	5.950	169	6.340	158	7.936	126
32	0.24	0.0097	0.1843	1.984	3.317	302	4.423	227	5.529	181	5.890	170	7.370	136

**TABLA DE PESOS APROXIMADOS EN KG.
DE PLACA DE ACERO A-36 EN MEDIDAS STANDARD**

Pies	Metros	3/16 4.88 mm	1/4 6.33 mm	5/16 7.9 mm	3/8 9.5 mm	1/2 12.4 mm	5/8 15.9 mm	3/4 19.1 mm	7/8 22.2 mm	1' 25.4 mm	1 1/4 31.7 mm	1 1/2 38.1 mm	2' 50.8 mm	2 1/2 63.5 mm
3 x 6	0.915 x 1.83	62	83	104	125	167	208	250	291	333				
3 x 8	0.915 x 2.44	83	111	139	167	222	278	333	389	444				
3 x 10	0.915 x 3.05	104	139	173	208	278	347	416	486	555				
3 x 20	0.915 x 6.10	208	278	346	416	556	694	832	972	1110				
4 x 8	1.22 x 2.44	111	148	185	222	296	370	444	518	592				
4 x 10	1.22 x 3.05	139	185	231	278	370	463	555	648	740				
4 x 20	1.22 x 6.10	278	370	462	556	740	926	1110	1296	1480				
5 x 20	1.52 x 6.10	347	463	578	694	925	1157	1388	1619	1851				
6 x 20	1.83 x 6.10	410	560	700	840	1120	1400	1650	1960	2220	2780	3340	4440	5680
8 x 20	2.44 x 6.10	556	740	924	1112	1480	1852	2220	2592	2960	3710	4460	5920	7580
	kg x m ²	37.35	49.80	62.25	74.70	99.61	124.51	149.41	174.31	199.21	249.00	299.00	398.42	498.03
	kg x pie ²	3.475	4.627	5.793	6.940	9.523	11.567	13.880	16.194	18.507	23.13	27.76	37.01	46.533

**PESOS Y MEDIDAS
PLACA Y LÁMINA ANTIDERRAPANTE**

Calibre	Medidas		Kg x m ²	3 x 8 0.91 x 2.44				3 x 10 0.91 x 3.05				3 x 20 0.91 x 6.10				4 x 8 1.22 x 2.44				4 x 10 1.22 x 3.05			
	Pulgadas	mm																					
14	0.747	1.90	18.380	40.800	51.030	102.060	54.140	68.500	129.000	102.060	51.030	40.800	54.140	68.500	129.000	102.060	54.140	68.500	129.000	102.060	54.140	68.500	129.000
12	0.1046	2.66	21.967	51.000	64.500	129.000	68.500	86.000	172.000	129.000	64.500	51.000	68.500	86.000	172.000	129.000	68.500	86.000	172.000	129.000	68.500	86.000	172.000
11	0.1196	3.04	24.420	60.000	70.000	140.000	75.000	95.000	190.000	140.000	70.000	60.000	75.000	95.000	190.000	140.000	75.000	95.000	190.000	140.000	75.000	95.000	190.000
1/8	0.1250	3.17	30.514	75.000	90.000	180.000	95.000	118.000	236.000	180.000	90.000	75.000	95.000	118.000	236.000	180.000	95.000	118.000	236.000	180.000	95.000	118.000	236.000
10	0.1345	3.42	32.352	76.000	97.000	194.000	76.000	102.000	204.000	194.000	97.000	76.000	102.000	135.000	270.000	194.000	102.000	135.000	270.000	194.000	102.000	135.000	270.000
3/16	0.1875	4.76	43.274	101.000	127.000	254.000	101.000	135.000	270.000	254.000	127.000	101.000	135.000	174.000	348.000	254.000	135.000	174.000	348.000	254.000	135.000	174.000	348.000
1/4	0.2500	6.35	56.034	132.000	164.000	328.000	132.000	174.000	348.000	328.000	164.000	132.000	174.000	218.000	436.000	328.000	174.000	218.000	436.000	328.000	174.000	218.000	436.000

LOSACERO Y GALVADEK

Sección 4	2.44 m	305 m	6.10 m
Calibre 22	18.144	22.68	45.36
Calibre 24	14.40	18.00	36.00
Sección 3	2.44 m	3.05 m	6.10 m
Calibre 22	13.608	17.01	34.02

H.S.S. - O.R.

Pulgadas Cuadrado Rectangular		Peso en kg/m					
		1/8"	3/16"	1/4"	5/16"	3/8"	1/2"
4" x 4"		9.61	14.02	18.17	22.07	25.70	32.19
	5" x 3"	9.61	14.02	18.17	22.07	25.70	32.19
	6" x 2"	9.61	14.02	18.17	22.07	25.70	32.19
4 1/2" x 4 1/2"		10.86	15.92	20.70	25.24	29.50	37.25
	5" x 4"	10.86	15.92	20.70	25.24	29.50	37.25
	6" x 3"	10.86	15.92	20.70	25.24	29.50	37.25
	7" x 2"	10.86	15.92	20.70	25.24	29.50	37.25
5" x 5"		12.13	17.81	23.25	28.39	33.29	42.31
	6" x 4"	12.13	17.81	23.25	28.39	33.29	42.31
	7" x 3"	12.13	17.81	23.25	28.39	33.29	42.31
	8" x 2"	12.13	17.81	23.25	28.39	33.29	42.31
5 1/2" x 5 1/2"			19.72	25.77	31.56	37.10	
	6" x 5"		19.72	25.77	31.56	37.10	
	7" x 4"		19.72	25.77	31.56	37.10	
	8" x 3"		19.72	25.77	31.56	37.10	
6" x 6"			21.62	28.30	34.73	40.89	52.44
	7" x 5"		21.62	28.30	34.73	40.89	52.44
	8" x 4"		21.62	28.30	34.73	40.89	52.44
	9" x 3"		21.62	28.30	34.73	40.89	52.44
	10" x 2"		21.62	28.30	34.73	40.89	52.44
7" x 7"			25.42	33.36	41.06	48.48	62.58
	8" x 6"		25.42	33.36	41.06	48.48	62.58
	9" x 5"		25.42	33.36	41.06	48.48	62.58
	10" x 4"		25.42	33.36	41.06	48.48	62.58
	12" x 2"		25.42	33.36	41.06	48.48	62.58
7 1/2" x 7 1/2"			27.31	35.89	44.23	52.28	67.64
	8" x 7"		27.31	35.89	44.23	52.28	67.64
	9" x 6"		27.31	35.89	44.23	52.28	67.64
	10" x 5"		27.31	35.89	44.23	52.28	67.64
	12" x 3"		27.31	35.89	44.23	52.28	67.64

Pulgadas		Peso en kg/m					
Cuadrado	Rectangular	1/8"	3/16"	1/4"	5/16"	3/8"	1/2"
8" x 8"			29.21	38.42	47.38	56.09	72.70
	9" x 7"		29.21	38.42	47.38	56.09	72.70
	10" x 6"		29.21	38.42	47.38	56.09	72.70
	12" x 4"		29.21	38.42	47.38	56.09	72.70
9" x 9"			33.01	43.50	53.72	63.68	82.83
	10" x 8"		33.01	43.50	53.72	63.68	82.83
	12" x 6"		33.01	43.50	53.72	63.68	82.83
	14" x 4"		33.01	43.50	53.72	63.68	82.83
10" x 10"			36.80	48.56	60.05	71.28	92.95
	12" x 8"		36.80	48.56	60.05	71.28	92.95
	14" x 6"		36.80	48.56	60.05	71.28	92.95
	16" x 4"		36.80	48.56	60.05	71.28	92.95
12" x 12"			44.41	58.68	72.71	86.46	113.20
	14" x 10"		44.41	58.68	72.71	86.46	113.20
	16" x 8"		44.41	58.68	72.71	86.46	113.20
	18" x 6"		44.41	58.68	72.71	86.46	113.20
	20" x 4"		44.41	58.68	72.71	86.46	113.20
14" x 14"					85.36	101.66	133.46
	16" x 12"				85.36	101.66	133.46
	20" x 8"				85.36	101.66	133.46
16" x 16"					98.03	116.85	153.73
	20" x 12"				98.03	116.85	153.73

CARACTERÍSTICAS DEL PERFIL P.E.R.

Propiedades de la tensión			
Esfuerzo de ruptura, mínimo		4,270 kg/cm ²	
Esfuerzo de fluencia, mínimo		3,500 kg/cm ²	
Elongación		Alargamiento en 50.80 mm. (2"), mínimo	
Espesor	mm	(pulg)	
	2.4	(0.095)	18 %
	2.8	(0.110)	19%
	3.2	(0.125)	20%
	3.4	(0.133)	20%
	4.0	(0.156)	21%
	4.8	(0.188)	23%
	Composición Química		
Elementos	Análisis		
	De cuchara	De comprobación	
Carbono max. %	0.23	0.27	
Manganeso max. %	1.35	1.40	
Fósforo max. %	0.04	0.05	
Azufre max. %	0.05	0.06	
Cobre cuando es especificado min. %	0.20	0.18	

**PERFIL ESTRUCTURAL RECTANGULAR
(P.E.R.), (P.T.R.), C.C. Y A.R.**

Dimensiones pulgadas	Exteriores mm	Espesor mm	Color	Peso x pieza kgs.
1 x 1	25 x 25	2.4	Verde	10.000
1 x 1	25 x 25	3.4	Rojo	12.800
1 1/2 x 1 1/2	38 x 38	2.8	Blanco	17.500
1 1/2 x 1 1/2	38 x 38	3.2	Verde	19.600
1 1/2 x 1 1/2	38 x 38	4.0	Rojo	23.600
2 x 2	51 x 51	2.8	Blanco	25.000
2 x 2	51 x 51	3.2	Verde	27.200
2 x 2	51 x 51	4.0	Rojo	32.500
2 1/2 x 2 1/2	64 x 64	3.2	Blanco	34.000
2 1/2 x 2 1/2	64 x 64	3.6	Verde	38.000
2 1/2 x 2 1/2	64 x 64	4.8	Rojo	48.000
3 x 2	76 x 51	3.2	Blanco	33.000
3 x 2	76 x 51	3.6	Verde	37.500
3 x 2	76 x 51	4.8	Rojo	47.200
3 x 3	76 x 76	3.2	Blanco	42.000
3 x 3	76 x 76	4.0	Verde	51.000
3 x 3	76 x 76	4.8	Rojo	62.000
3 1/2 x 3 1/2	89 x 89	3.2	Blanco	47.500
3 1/2 x 3 1/2	89 x 89	4.0	Verde	60.000
3 1/2 x 3 1/2	89 x 89	4.8	Rojo	71.000
4 x 2	102 x 51	3.2	Blanco	42.600
4 x 2	102 x 51	4.0	Verde	50.000
4 x 2	102 x 51	4.8	Rojo	61.200
4 x 3	102 x 76	3.2	Blanco	48.000
4 x 3	102 x 76	4.0	Verde	60.000
4 x 3	102 x 76	4.8	Rojo	71.000
4 x 4	102 x 102	3.2	Blanco	57.660
4 x 4	102 x 102	4.0	Verde	70.980
4 x 4	102 x 102	4.8	Rojo	84.600

PERFIL TUBULAR PINTADO Y GALVANIZADO

Calibre	No.	Kgs/pza	Piezas p/atado	Calibre	No.	Kgs/pza	Piezas p/atado
18	101	7.300	10	18	P-150	9.300	8
20	101	5.600	10	20	P-150	7.100	8
18	103	8.700	10	18	P-200	11.800	8
20	103	6.500	10	20	P-200	8.800	8
18	106	8.700	10	18	P-250	11.500	6
20	106	6.500	10	20	P-250	9.300	6
20	116	9.100	8	18	P-300	13.800	5
18	119	11.200	5	20	P-300	10.600	6
20	119	8.700	5	18	P-400	16.500	4
18	120	8.000	8	20	P-400	12.600	4
20	120	6.200	8	18	K-150	11.000	9
18	121	8.100	8	20	K-150	8.500	9
20	121	6.100	8	20	K-300	10.700	10
18	122	8.000	10	18	C-050	2.800	20
20	122	6.100	10	20	C-050	2.200	20
20	123	6.600	10	18	C-075	4.100	20
18	124	4.200	10	20	C-075	3.300	20
18	126	9.900	8	14	C-100	8.400	10
20	126	7.600	8	16	C-100	6.900	10
18	127	11.200	5	18	C-100	5.500	10
20	127	8.500	5	20	C-100	4.300	10
20	131	4.000	20	14	C-125	10.800	8
18	144	9.100	10	16	C-125	8.900	10
20	144	6.800	10	18	C-125	7.000	10
20	145	3.900	20	20	C-125	5.400	10
18	154	1.600	50	14	C-150	13.300	1
20	154	1.200	50	16	C-150	10.500	1
20	155	1.500	50	18	C-150	8.600	10
20	156	2.100	25	20	C-150	6.600	10

PERFIL TUBULAR PINTADO Y GALVANIZADO

Calibre	No.	Kgs/pza	Piezas p/atado	Calibre	No.	Kgs/pza	Piezas p/atado
18	160	8.500	10	14	C-200	17.600	1
20	160	6.400	10	16	C-200	14.000	1
20	170	9.400	8	18	C-200	11.400	8
20	180	13.400	6	14	C-250	22.900	1
18	1400	7.300	12	18	R-100	4.100	20
14	1500	17.900	4	18	R-125	5.300	10
16	1500	14.600	4	20	R-125	4.300	10
18	M-138	7.100	12	18	R-175	7.100	10
20	M-138	5.400	12	20	R-175	5.500	10
18	M-225	7.700	8	18	R-200	8.500	10
20	M-225	5.800	8	20	R-200	6.500	10
20	M-600	9.700	7	18	R-225	8.600	10
20	M-725	10.900	6	18	R-249	10.300	8
18	P-100	8.100	8	20	R-249	8.300	8
20	P-100	6.100	8	14	R-250	18.000	
				12	R-250	24.600	

PERFIL TUBULAR PINTADO

Calibre	No.	Kgs/pza	Piezas p/atado
14	R-300	19.700	1
16	R-300	15.400	1
18	R-300	12.800	6
20	R-300	9.500	6
14	R-400	23.900	1
16	R-400	19.500	1
18	R-400	15.900	4
20	R-400	11.700	4

POLINES ESTRUCTURALES

Peralte		Patín mm	Longitud m	Calibre	Kgs x pieza	Tipo de lámina	
mm	Pulgadas						
76	3	38	6	14	14.900	C.C.	
101	4	50	4	14	13.500	C.C.	
101	4	50	5	14	16.800	C.C.	
101	4	50	6	14	20.500	C.C.	
127	5	50	5	14	18.800	C.C.	
152	5	50	6	14	22.500	C.C.	
152	6	50	6	12	33.500		A.R.
152	6	50	6	14	24.500	C.C.	A.R.
203	8	69	8	10	78.500		A.R.
203	8	69	8	12	60.000		A.R.
203	8	69	8	14	43.800	C.C.	A.R.
254	10	69	10	10	108.000		A.R.
254	10	69	10	12	86.000		A.R.
254	10	69	10	14	63.000	C.C.	A.R.
304	12	89	12	10	160.000		A.R.
304	12	89	12	12	127.000		A.R.

TABLA DE RESISTENCIAS POLINES ESTRUCTURALES

	A.R.	C.C.
Resistencia a la tensión en kgs./cm ²	5,000	3,400
Límite de fluencia en kgs./cm ²	3,500	2,100
Alargamiento en 5.1 cm.	22 %	28 %

TABLEROS CAL. 20

TABLERO GALVANIZADO

No.	Medida m	Kgs/pza	4' pies (1.22 m) Cal. 20		
148	0.91 x 0.91	5.600	4 x 3	1.22 x 0.915	7.890
148	0.91 x 1.83	11.800	4 x 4	1.22 x 1.22	10.200
148	0.91 x 2.44	15.800	4 x 6	1.22 x 1.83	14.860
148	0.91 x 3.05	19.700	4 x 6 1/2	1.22 x 1.98	17.210
			4 x 8	1.22 x 2.44	21.210
			4 x 10	1.22 x 3.05	26.910

VAGUETA ALUMINIO KG POR PIEZA

		1/2	3/8	
Oro	No. 1	0.250		kg
Oro	No. 2	0.300		kg
Oro	No. 3	0.38		kg
Oro			0.200	kg
Plata		0.250		kg

CANALES - C.P.S. en largos de 6.10 y 12.20 m

Perfil		Peso		Ancho del Patín		Espesor del Patín		Espesor del Alma	
Pulg.	mm.	Kg/m	Lbs/Ft	Pulg.	mm.	Pulg.	mm.	Pulg.	mm.
3	76.2	6.10	4.10	1.410	36	0.273	7.0	0.170	4.3
4	101.6	8.04	5.40	1.584	40	0.296	7.5	0.184	4.7
5	127.0	10.40	6.70	1.750	44	0.320	8.1	0.190	4.8
6	152.4	12.20	8.20	1.920	48	0.343	8.7	0.200	5.1
		15.63	10.50	2.034	51	0.343	8.7	0.314	8.0
		19.35	13.00	2.157	55	0.343	8.7	0.437	11.1
8	203.2	17.11	11.50	2.260	57	0.390	9.9	0.220	5.6
		20.46	13.75	2.343	59	0.390	9.9	0.303	7.7
		27.90	18.75	2.527	64	0.390	9.9	0.487	12.4
10	254.0	22.76	15.30	2.600	65	0.436	11.1	0.240	6.1
		29.76	20.00	2.739	69	0.436	11.1	0.379	9.6
		37.20	25.00	2.886	73	0.436	11.1	0.526	13.4
		44.64	30.00	3.033	76	0.436	11.1	0.673	17.1
12	304.8	30.80	20.70	2.942	74	0.501	12.7	0.282	7.2
		37.20	25.00	3.047	77	0.501	12.7	0.387	9.8
		44.64	30.00	3.170	80	0.501	12.7	0.510	13.0

VIGUETA I.P.R.

Perfil I.P.R. dxb	Peso kg/m	Área cm ²	Peralte mm	Patín		Espesor del Alma mm
				Ancho mm	Espesor mm	
6" x 4"	13.4	17.29	149.86	100.07	5.46	4.31
152.4 x 101.6	17.9	22.77	152.00	102.00	7.1	5.8
	23.8	30.45	159.00	102.00	10.3	6.6
8" x 4"	14.9	19.03	201.00	100.00	5.2	4.3
203.2 x 101.6	19.4	24.71	203.00	102.00	6.5	5.8
	22.4	28.58	206.00	102.00	8.0	6.2
8" x 5 1/4"	26.9	33.93	206.75	133.85	8.38	5.84
203.2 x 133.4	31.3	39.74	210.31	133.85	10.16	6.35
10" x 4"	17.9	21.87	251.00	100.00	5.2	4.6
254.0 x 101.6	22.4	28.38	254.00	102.00	6.8	5.8
	25.5	32.13	257.00	102.00	8.4	6.1
	28.3	36.19	260.00	102.00	10.0	6.4
10" x 5 3/4"	32.8	41.87	258.31	146.05	9.14	6.09
254.0 x 146.0	38.7	49.09	262.38	146.55	11.17	6.60
	44.7	57.03	265.93	147.57	12.95	7.62
12" x 4"	20.8	26.71	302.00	100.00	5.7	5.1
304.8 x 101.6	23.8	30.38	304.54	101.34	6.73	5.58
	28.3	36.25	309.00	102.00	8.9	6.1
	32.8	41.74	313.00	102.00	10.8	6.6
12" x 6 1/2"	38.7	49.35	310.38	164.84	9.65	5.84
304.8 x 165.1	44.7	56.70	313.43	165.60	11.17	6.60
	52.2	66.45	317.50	166.62	13.20	7.62
12" x 8"	59.6	75.94	303.00	203.00	13.1	7.5
304.8 x 203.2	67.1	85.42	306.00	204.00	14.6	8.5
	74.5	94.90	309.00	205.00	16.3	9.4
14" x 6 3/4"	44.7	56.84	352.00	171.00	9.7	6.9
355.6 x 171.4	50.7	64.52	356.00	171.00	11.5	7.3
	56.6	72.06	359.00	172.00	13.0	7.9
14" x 8"	64.1	81.61	347.00	203.00	13.4	7.8
355.6 x 203.2	71.5	91.03	351.00	204.00	15.1	8.6
	79.0	100.58	354.00	205.00	16.7	9.4

VIGUETA I.P.R.

Perfil I.P.R. dxh	Peso kg/m	Área cm ²	Peralte mm	Patín		Espesor del Alma mm
				Ancho mm	Espesor mm	
16" X 7"	53.6	68.32	403.00	177.00	10.9	7.6
406.4 X 177.8	59.6	75.94	406.00	178.00	12.7	7.8
	67.1	85.42	409.00	179.00	14.3	8.8
	74.5	94.84	413.00	180.00	15.9	9.6
18" X 7 1/2"	74.4	94.80	457.00	192.78	19.0	9.0
457.2 X 190.5	82.0	104.5	457.00	192.78	19.1	9.9
	89.3	113.6	457.00	192.78	19.2	10.5
	96.9	123.22	466.09	192.78	19.5	11.43
	105.6	134.19	469.13	193.92	20.57	12.57
18" X 11"	113.2	143.87	462.53	280.29	17.27	10.79
457.2 X 279.4	128.1	163.22	467.10	281.68	19.55	12.19
	144.3	183.87	472.18	283.08	22.09	13.58
	157.7	200.64	475.74	284.48	23.87	14.98
	177.3	266.45	481.83	286.13	26.92	16.63
21" X 6 1/2"	65.6	83.9	525	165	11.4	8.9
530 X 165	74.5	94.8	529	166	13.6	9.7
	84.8	108	535	166	16.5	10.3
24" X 9"	101.3	130	603	228	14.9	10.5
610 X 230	113.3	145	608	228	17.3	11.2
	125.2	159	612	229	19.6	11.9
	140.1	179	617	230	22.2	13.1
	153.5	196	623	229	24.9	14.0

VIGA I.P.S.

Peralte		Peso		Ancho del Patín		Ancho del Alma	
Pulg.	mm.	kg/m	Lbs/Ft	Pulg.	mm.	Pulg.	mm.
3	76.2	8.48	5.7	2.33	59	0.17	4
4	101.6	11.46	7.7	2.66	68	0.19	5
5	127.0	14.88	10.0	3.00	76	0.21	5
6	152.4	18.60	12.5	3.33	85	0.23	6
8	200.0	26.20	17.6	3.54	90	0.30	7

CARAMELO

VARILLA CORRUGADA ALTA RESISTENCIA

G-42 a 9.15 X 12 mts

CUADRADOS

REDONDOS

Caramelo			Varilla Corrugada			Cuadrados			Redondos		
Medida	kgs.		Medida	kgs.		Medida	kgs.		Medida	kgs.	
Pulg.	mm	x m.	Pulg.	mm	x m.	Pulg.	mm	x m.	Pulg.	mm	x m.
3/8	9.5	0.712	5/16	7.9 (2.5)	0.388	3/8	9.5	0.712	3/8	9.5	0.559
			3/8	9.5 (3)	0.559	1/2	12.7	1.266	1/2	12.7	0.994
1/2	12.7	1.266	1/2	12.7 (4)	0.994	5/8	15.9	1.978	5/8	15.9	1.552
			5/8	15.9 (5)	1.552	3/4	19.1	2.849	3/4	19.1	2.235
5/8	15.9	1.978	3/4	19.1 (6)	2.235	7/8	22.2	3.870	7/8	22.2	3.045
			7/8	22.2 (7)	3.045	1	25.4	5.065	1	25.4	3.973
3/4	19.1	2.849	1	25.4 (8)	3.973	1 1/4	31.7	7.913	1 1/8	28.6	5.022
			1 1/4	31.7 (10)	6.205	1 1/2	38.1	11.395	1 1/4	31.7	6.208
1"	25.4	5.065	1 1/2	38.1 (12)	9.008	2	50.8	20.258	1 3/8	34.9	7.514
						2 1/2	63.5	31.653	1 1/2	38.1	9.000
									1 5/8	41.3	10.490
									1 3/4	44.4	12.170
									2	50.8	15.890
									2 1/4	57.1	20.110
									2 1/2	63.5	24.830
									3	76.2	35.766

TIRA DE CORTINA

Cal. 24	2.55 m
Cal. 24	3.05 m
Cal. 24	4.05 m
Cal. 24	5.05 m
Cal. 24	5.50 m
Cal. 24	6.10 m

CUADRADO LIGERO

Medida	kgs. xm.	
Pulg.	mm	
1/2	12	1.09

CLAVO

Con Cabeza	1"	1 1/4"	1 1/2"	1 3/4"	2"	2 1/2"	3"	3 1/2"	4"	5"	6"
Sin Cabeza	1"		1 1/2"		2"	2 1/2"					

ÁNGULOS

Medidas						Kgs. x m.
Pulg.			mm			
1/8	x	3/4	3.2	x	19.1	0.880
	x	1		x	25.4	1.190
	x	1 1/4		x	31.7	1.500
	x	1 1/2		x	38.1	1.830
	x	2		x	50.8	2.460
3/16	x	1	4.8	x	25.4	1.730
	x	1 1/4		x	31.7	2.200
	x	1 1/2		x	38.1	2.680
	x	2		x	50.8	3.630
	x	2 1/2		x	63.5	4.600
	x	3		x	76.2	5.970
1/4	x	1	6.3	x	25.4	2.220
	x	1 1/4		x	31.7	2.860
	x	1 1/2		x	38.1	3.490
	x	2		x	50.8	4.750
	x	2 1/2		x	63.5	6.100
	x	3		x	76.2	7.290
	x	3 1/2		x	88.9	8.630
	x	4		x	101.6	9.900
5/16	x	2	7.9	x	50.8	5.840
	x	2 1/2		x	63.5	7.440
	x	3		x	76.2	9.080
	x	4		x	101.6	12.200
3/8	x	2	9.5	x	50.8	6.990
	x	2 1/2		x	63.5	8.790
	x	3		x	76.2	10.720
	x	4		x	101.6	14.600
	x	6		x	152.4	22.170
1/2	x	3	12.7	x	76.2	13.990
	x	4		x	101.6	19.000
	x	6		x	152.4	29.170
5/8	x	6	15.9	x	152.4	36.010
3/4	x	6	19.1	x	152.4	42.710

ÁNGULOS LIGEROS

Medidas		kgs. x m.
Pulg.	mm	
1 x 0.109	25.4 x 2.7	1.010
1 1/4 x 0.109	31.7 x 2.7	1.300
1 1/2 x 0.109	38.1 x 2.7	1.580

ÁNGULOS DESIGUALES

Medidas		kgs. x m.
Pulg.	mm	
4 X 6	101.6 X 152.4	
3/8	9.5	18.300
1/2	12.7	24.110
5/8	15.9	29.760
3/4	19.1	35.120

SOLERAS

SOLERAS

Medidas			Medidas			
Pulgadas		Milímetros	k x m	Pulgadas	Milímetros	k x m
1/8	x	1/2	3.2	x	12.7	0.317
	x	5/8		x	15.9	0.396
	x	3/4		x	19.1	0.474
	x	1		x	25.4	0.633
	x	1 1/4		x	31.7	0.791
	x	1 1/2		x	38.1	0.950
	x	2		x	50.8	1.266
	x	2 1/2		x	63.5	1.582
	x	3		x	76.2	1.899
3/16	x	1/2	4.8	x	12.7	0.474
	x	5/8		x	15.9	0.593
	x	3/4		x	19.1	0.712
	x	1		x	25.4	0.950
	x	1 1/4		x	31.7	1.187
	x	1 1/2		x	38.1	1.424
	x	2		x	50.8	1.899
	x	2 1/2		x	63.5	2.374
	x	3		x	76.2	2.849
1/4	x	1/2	6.3	x	12.7	0.633
	x	5/8		x	15.9	0.791
	x	3/4		x	19.1	0.950
	x	1		x	25.4	1.266
	x	1 1/4		x	31.7	1.583
	x	1 1/2		x	38.1	1.899
	x	2		x	50.8	2.532
	x	2 1/2		x	63.5	3.165
	x	3		x	76.2	3.798
	x	4		x	101.6	5.064
	x	5		x	127.0	6.330
	x	6		x	152.4	7.596
	x	8		x	203.2	10.128
	x	10		x	254.0	12.660
5/16	x	1	7.9	x	25.4	1.583
	x	1 1/4		x	31.7	1.978
	x	1 1/2		x	38.1	2.374
	x	2		x	50.8	3.165
	x	2 1/2		x	63.5	3.957
	x	3		x	76.2	4.748
	x	4		x	101.6	6.331
	x	5		x	127.0	7.914
	x	6		x	152.4	9.496
3/8	x	1	9.5	x	25.4	1.899
	x	1 1/4		x	31.7	2.374
	x	1 1/2		x	38.1	2.849
	x	2		x	50.8	3.798
	x	2 1/2		x	63.5	4.748
3/8	x	3		x	76.2	7.597
	x	4		x	101.6	10.129
	x	5		x	127.0	12.662
	x	6		x	152.4	15.194
	x	8		x	203.2	20.260
	x	10		x	254.0	25.320
1/2	x	1	12.7	x	25.4	2.532
	x	1 1/4		x	31.7	3.165
	x	1 1/2		x	38.1	3.798
	x	2		x	50.8	5.064
	x	2 1/2		x	63.5	6.331
	x	3		x	76.2	7.597
	x	4		x	101.6	10.129
	x	5		x	127.0	12.662
	x	6		x	152.4	15.194
	x	8		x	203.2	20.260
	x	10		x	254.0	25.320
5/8	x	1	15.9	x	25.4	3.165
	x	1 1/4		x	31.7	3.957
	x	1 1/2		x	38.1	4.748
	x	2		x	50.8	6.331
	x	2 1/2		x	63.5	7.913
	x	3		x	76.2	9.496
	x	4		x	101.6	12.661
	x	5		x	127.0	15.826
	x	6		x	152.4	18.992
	x	8		x	203.2	25.320
	x	10		x	254.0	31.650
3/4	x	1 1/2	19.1	x	38.1	5.698
	x	2		x	50.8	7.597
	x	2 1/2		x	63.5	9.496
	x	3		x	76.2	11.395
	x	4		x	101.6	15.194
	x	5		x	127.0	18.992
	x	6		x	152.4	22.790
	x	8		x	203.2	30.388
	x	10		x	254.0	37.985
1	x	2	25.4	x	50.8	10.129
	x	2 1/2		x	63.5	12.661
	x	3		x	76.2	15.194
	x	4		x	101.6	20.258
	x	5		x	127.0	25.322
	x	6		x	152.4	30.388
	x	8		x	203.2	40.516
	x	10		x	254.0	50.645

SOLERAS CORTADAS DE LÁMINA

Medidas				k x m
Pulgadas		Milímetros		
1/8 x 1/2		3.2 x 12.7		0.317
1/8 x 3/4		3.2 x 19.1		0.474
1/8 x 1		3.2 x 25.4		0.633
	1 1/4	3.2 x 31.7		0.791
	1 1/2	3.2 x 38.1		0.950
3/16 x 1/2		3.2 x 12.7		0.474

SOLERA PASAMANO

Kilos por metro		
1,900		

TE

1/8 x 3/4	3.2 x 19.1	0.910
1/8 x 1	3.2 x 25.4	1.320

ZETA

1/8 x 5/8 x 1	32 x 25.4	1.210
---------------	-----------	-------

PERFILES TUBULARES MUESTRARIO

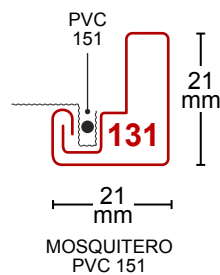
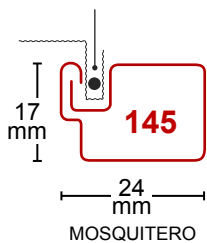
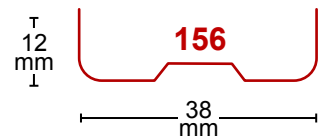
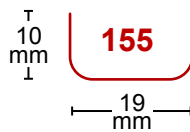
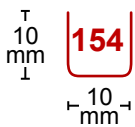
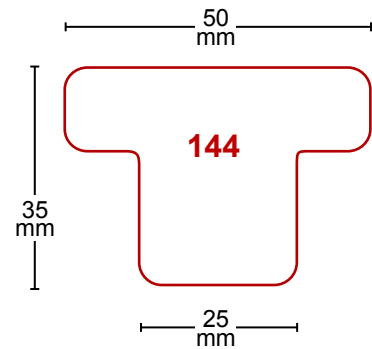
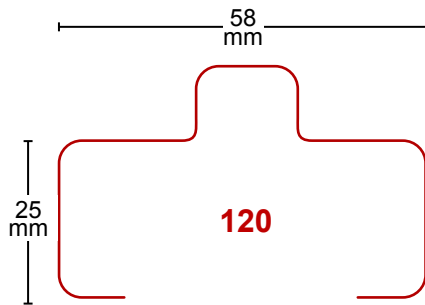
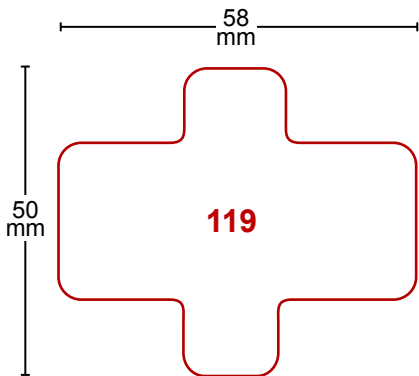
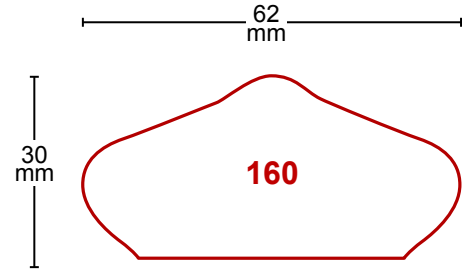
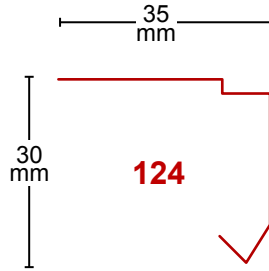
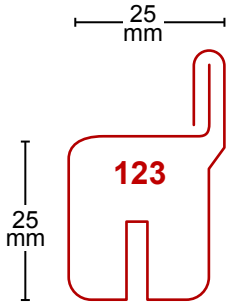
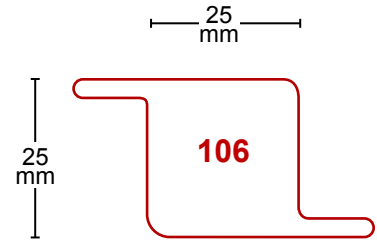
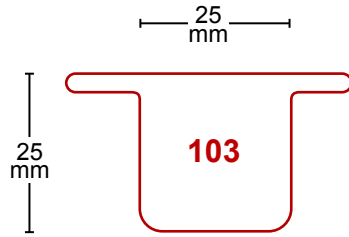
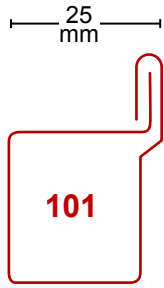

PERFILES TUBULARES MUESTRARIO

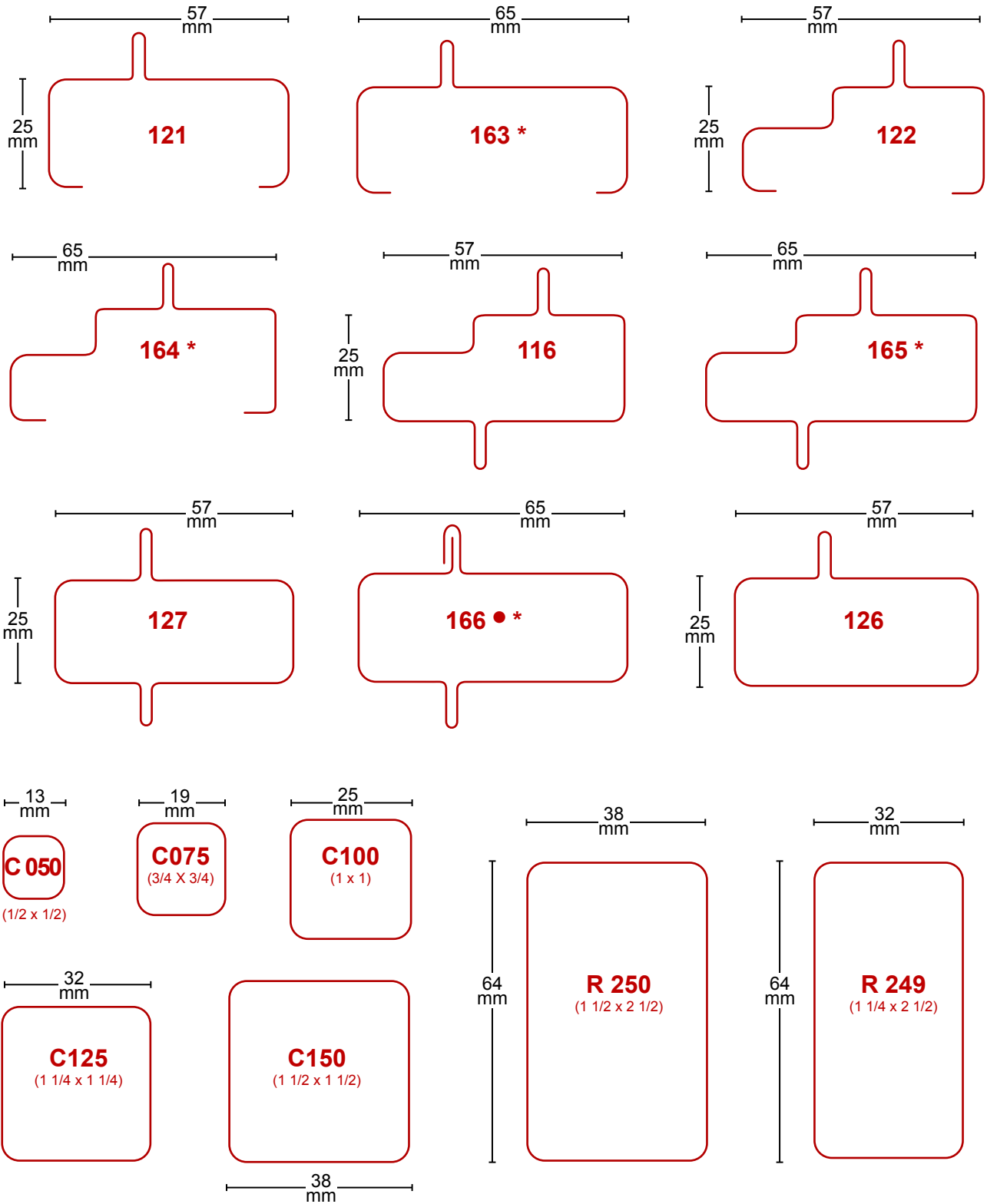

• Perfil de 3.05 m de longitud
 * Sobre pedido
 Tope portavidrio ancho h = 13 mm (1/2)
 Tope portavidrio angosto h = 13 mm (1/2)

PERFILES TUBULARES MUESTRARIO

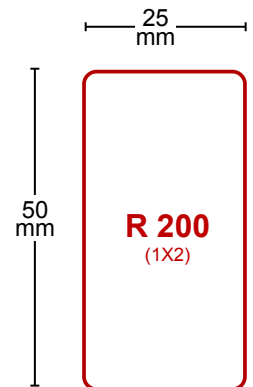
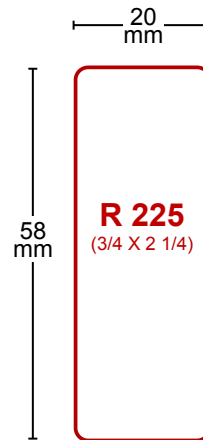
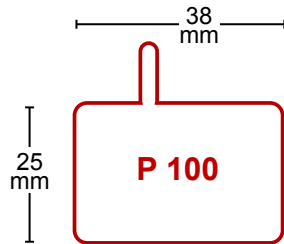
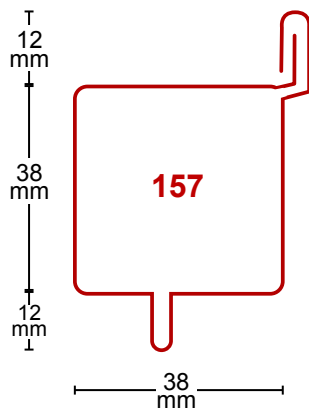
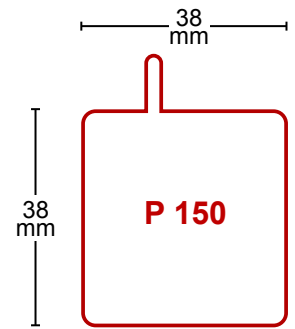
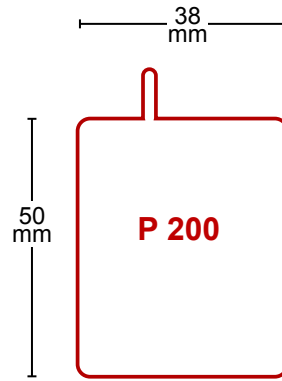
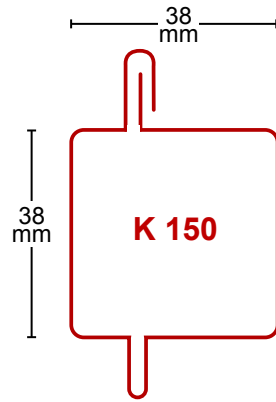
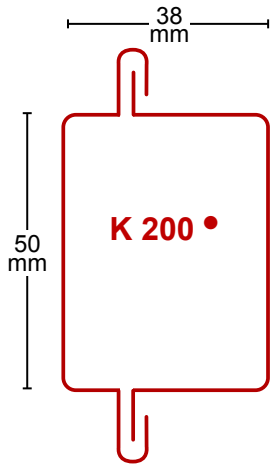
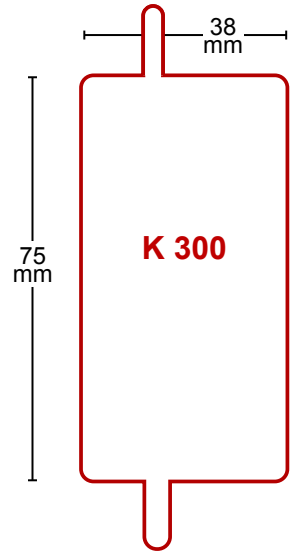
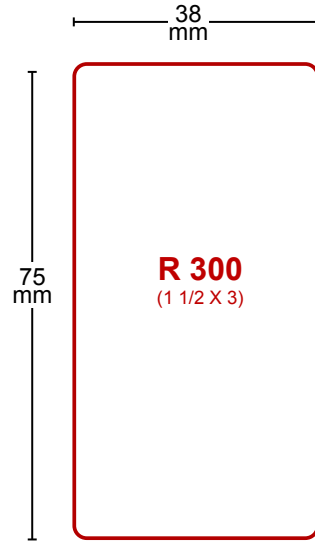
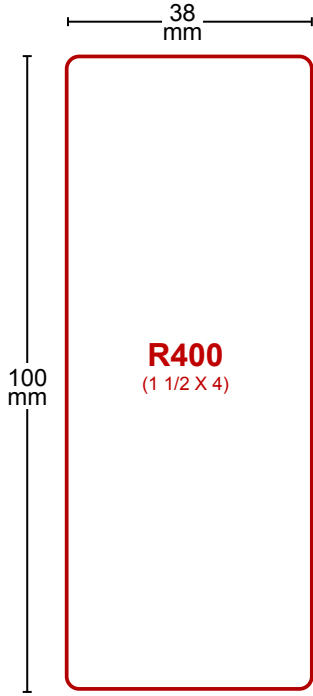

PERFILES TUBULARES MUESTRARIO

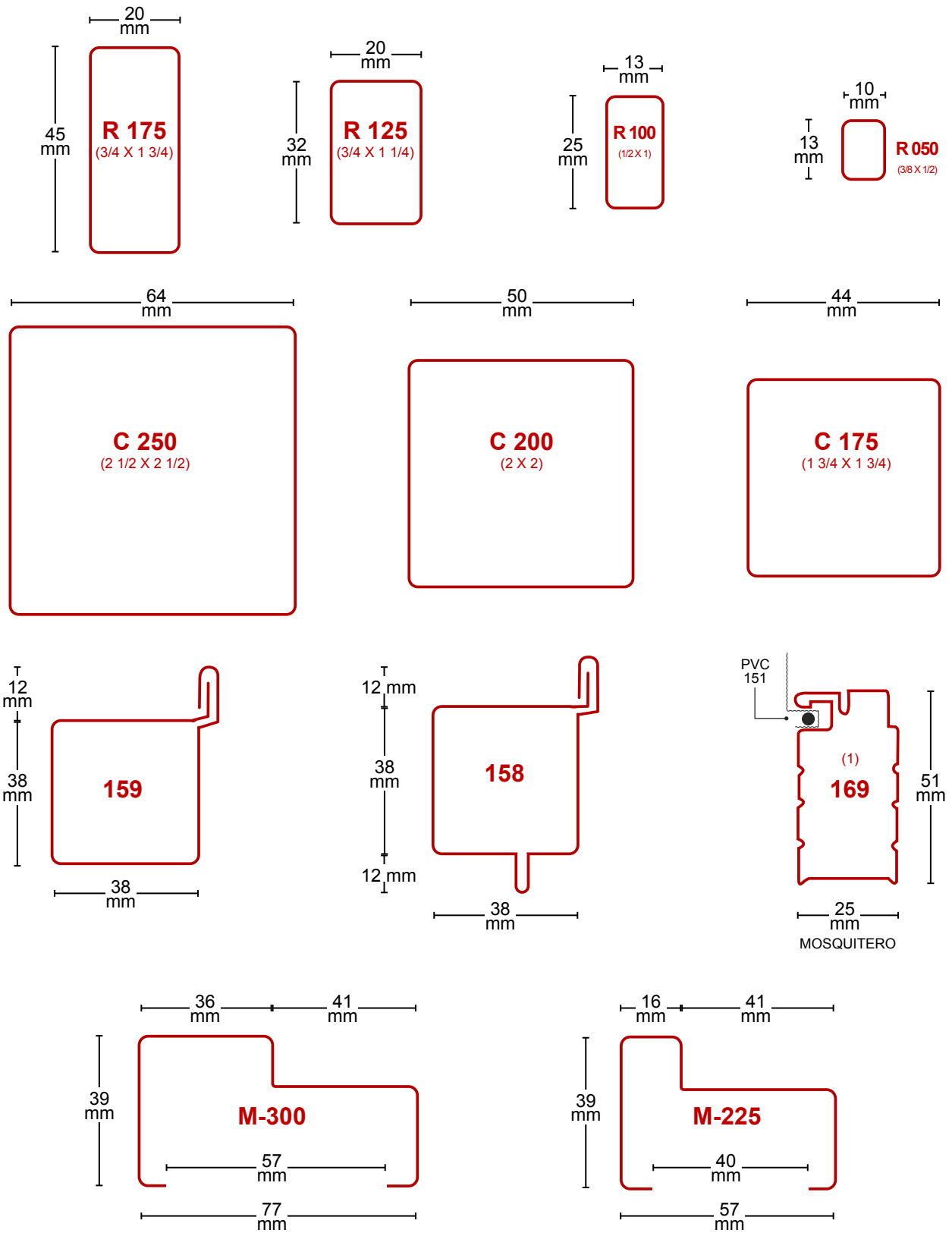

PERFILES TUBULARES MUESTRARIO

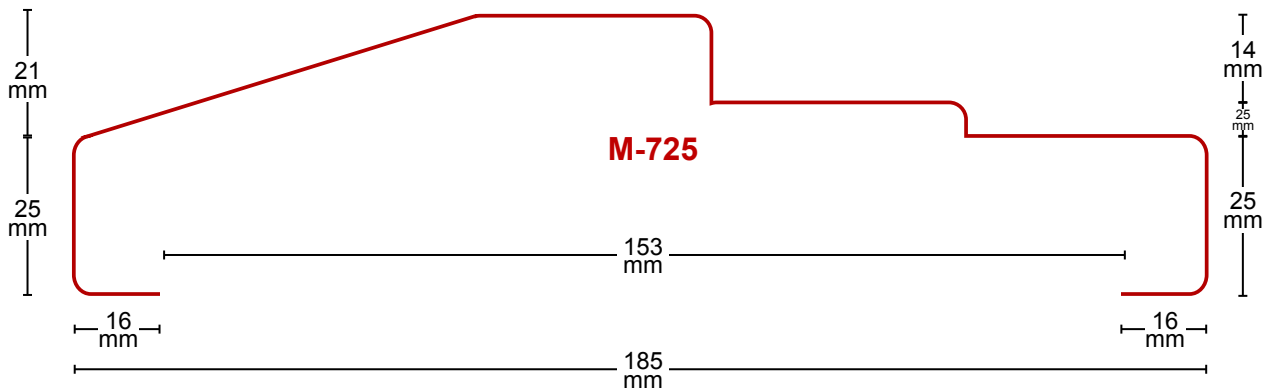
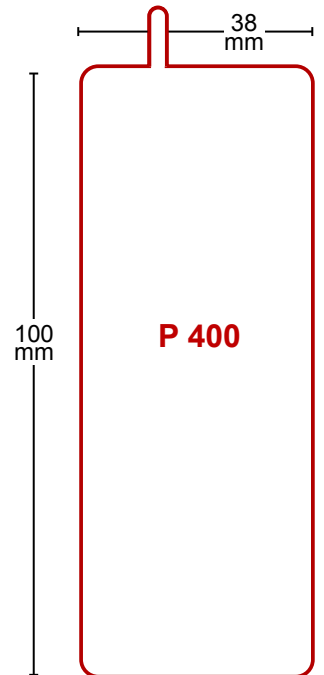
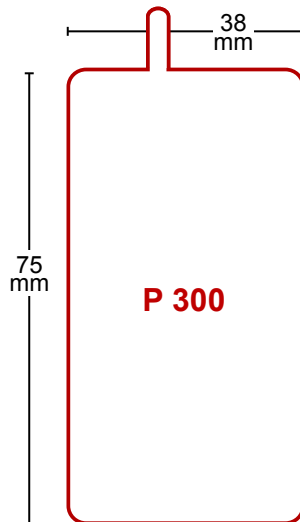
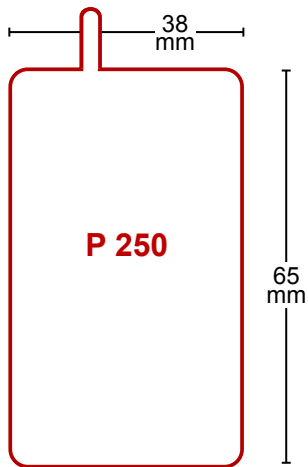
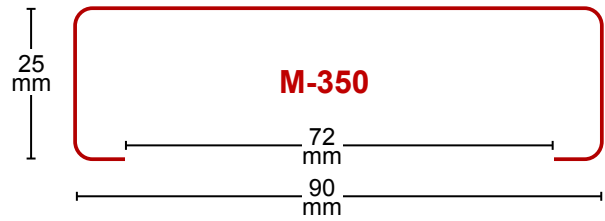
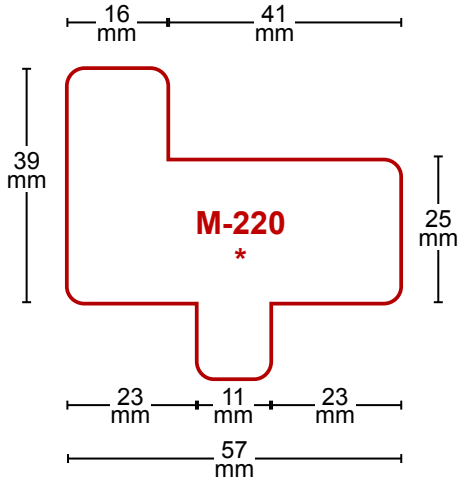
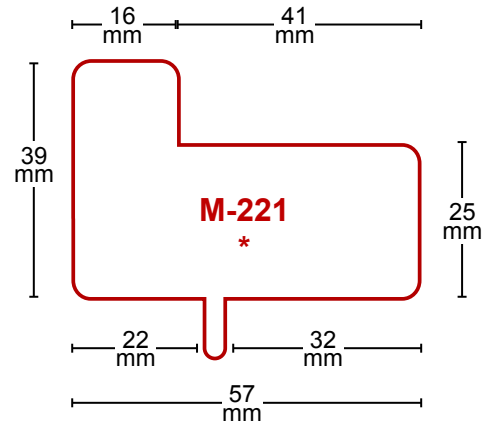
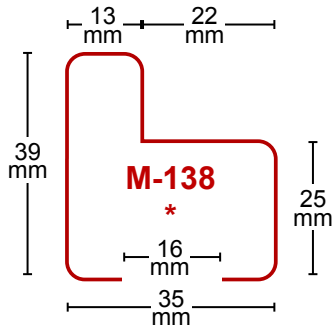

* Sobre pedido

PERFILES TUBULARES MUESTRARIO

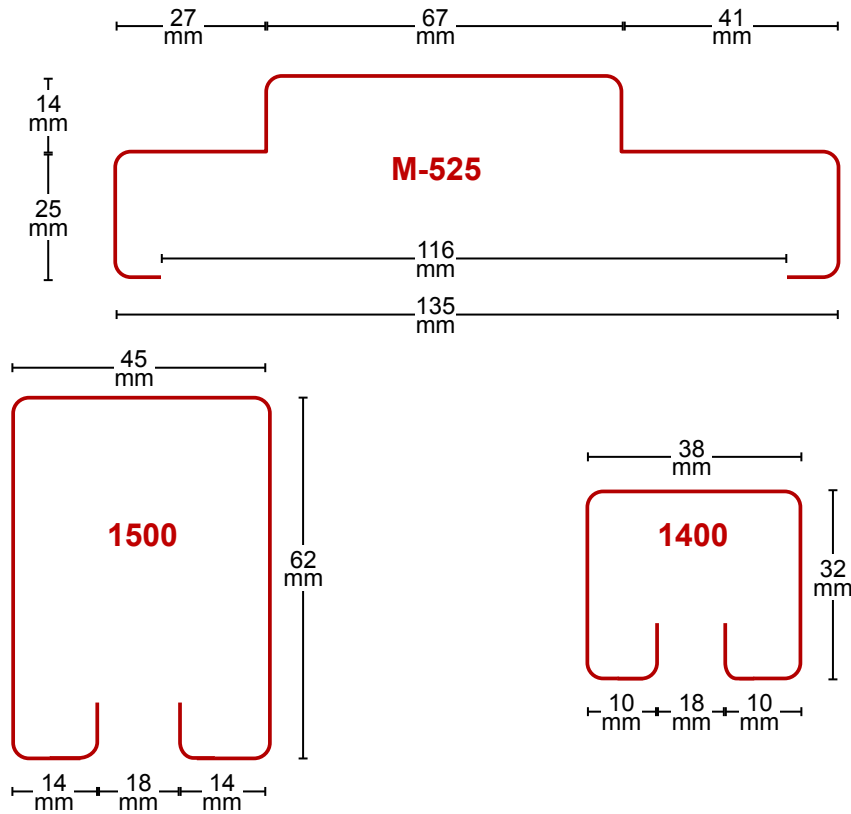

DUELA PARA ENSAMBLAR

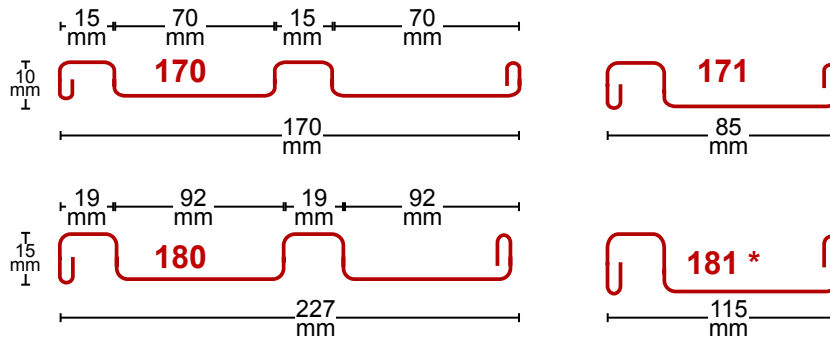

TABLEROS PARA PUERTAS

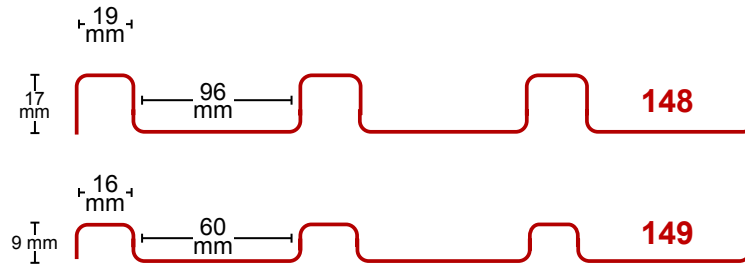

* Sobre pedido